

High temperature 50 A SCRs

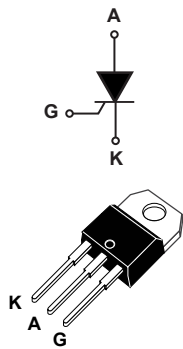

TO-220AB insulated

Features

- High junction temperature: $T_j = 150\text{ }^\circ\text{C}$
- High noise immunity $dV/dt = 500\text{V}/\mu\text{s}$ up to $150\text{ }^\circ\text{C}$
- Gate triggering current $I_{GT} = 15\text{ mA}$
- Peak off-state voltage $V_{DRM}/V_{RRM} = 600\text{ V}$
- High turn-on current rise $dI/dt = 100\text{ A}/\mu\text{s}$
- ECOPACK[®]2 compliant
- Insulated package TO-220AB:
 - Insulated voltage: 2500 V_{RMS}
 - Complies with UL 1557 (File ref : E81734)

Applications

- Motorbike voltage regulator circuits
- Inrush current limiting circuits
- Motor control circuits and starters
- Solid state relays
- Overvoltage crowbar protection

Description

The **TN5015H-6I** offers high thermal performance operation up to 50 A thanks to its junction temperature T_j up to $150\text{ }^\circ\text{C}$. Its fully tab insulated (thanks to ceramic inside) TO-220AB package allows a back to back configuration.

Its trade-off noise immunity ($dV/dt = 500\text{ V}/\mu\text{s}$) versus its gate triggering current ($I_{GT} = 15\text{ mA}$) and its turn-on current rise ($dI/dt = 100\text{ A}/\mu\text{s}$) allow to design robust and compact control circuit for voltage regulator in motorbikes and industrial drives, overvoltage crowbar protection, motor control circuits in power tools and kitchen appliances, inrush current limiting circuits.

Product status	
TN5015H-6I	
Product summary	
Order code	TN5015H-6I
Package	TO-220AB Ins.
V_{DRM}/V_{RRM}	600 V
I_{GT}	15 mA

1 Characteristics

Table 1. Absolute maximum ratings (limiting values), $T_j = 25\text{ °C}$ unless otherwise specified

Symbol	Parameter	Value	Unit
$I_{T(RMS)}$	RMS on-state current (180 ° conduction angle)	$T_c = 75\text{ °C}$ 50	A
$I_{T(AV)}$	Average on-state current (180 ° conduction angle)	$T_c = 81\text{ °C}$ 30	A
		$T_c = 97\text{ °C}$ 25	
		$T_c = 111\text{ °C}$ 20	
I_{TSM}	Non repetitive surge peak on-state current (T_j initial = 25 °C)	$t_p = 8.3\text{ ms}$ 493	A
		$t_p = 10\text{ ms}$ 450	
$I_{PP}^{(1)}$	$R_{G-A} = 3\text{ k}\Omega$, 8/20 us current shape, 10 pulses	1500	A
I^2t	I^2t value for fusing	$t_p = 10\text{ ms}$ 1012	A^2s
di/dt	$I_G = 2 \times I_{GT}$, $t_r \leq 100\text{ ns}$ Critical rate of rise of on-state current	$f = 60\text{ Hz}$ 100	$A/\mu s$
V_{DRM}/V_{RRM}	Repetitive peak off-state voltage	$T_j = 150\text{ °C}$ 600	V
V_{DSM}/V_{RSM}	Non repetitive surge peak off-state voltage	$t_p = 10\text{ ms}$ $V_{DRM}/V_{RRM} + 100$	V
I_{GM}	Peak gate current	$t_p = 20\text{ }\mu s$ $T_j = 150\text{ °C}$ 4	A
$P_{G(AV)}$	Average gate power dissipation	$T_j = 150\text{ °C}$ 1	W
V_{RGM}	Maximum peak reverse gate voltage	5	V
T_{stg}	Storage junction temperature range	-40 to +150	°C
T_j	Maximum operating junction temperature	-40 to +150	°C
T_l	Maximum lead temperature soldering during 10 s	260	°C
V_{ins}	Insulation RMS voltage, 1 minute	2500	V

1. According to IEC61000-4-5 standard (See Section 2)

Table 2. Electrical characteristics ($T_j = 25\text{ °C}$ unless otherwise specified)

Symbol	Test conditions	Value	Unit
I_{GT}	$V_D = 12\text{ V}$, $R_L = 33\text{ }\Omega$	Max.	15 mA
V_{GT}		Max.	1.3 V
V_{GD}	$V_D = V_{DRM}$, $R_L = 3.3\text{ k}\Omega$	$T_j = 150\text{ °C}$ Min.	0.15 V
I_H	$I_T = 500\text{ mA}$, gate open	Max.	60 mA
I_L	$I_G = 1.2 \times I_{GT}$	Max.	80 mA
dV/dt	$V_D = 402\text{ V}$, gate open	$T_j = 150\text{ °C}$ Min.	500 $V/\mu s$
t_{gt}	$I_{TM} = 100\text{ A}$, $V_D = 402\text{ V}$, $I_G = 30\text{ mA}$, $(dI_G/dt)_{max} = 0.2\text{ A}/\mu s$	Typ.	1.9 μs
t_q	$I_{TM} = 100\text{ A}$, $V_D = 402\text{ V}$, $(dI_T/dt)_{max} = 30\text{ A}/\mu s$, $V_R = 25\text{ V}$, $dV_D/dt = 50\text{ V}/\mu s$	$T_j = 150\text{ °C}$ Typ.	85 μs

Table 3. Static characteristics

Symbol	Test conditions			Value	Unit
V_{TM}	$I_{TM} = 100\text{ A}$, $t_p = 380\ \mu\text{s}$	$T_j = 25\ ^\circ\text{C}$	Max.	1.65	V
V_{TO}	Threshold voltage	$T_j = 150\ ^\circ\text{C}$	Max.	0.85	
R_D	Dynamic resistance	$T_j = 150\ ^\circ\text{C}$	Max.	9	m Ω
I_{DRM} , I_{RRM}	$V_D = V_{DRM} = V_{RRM}$	$T_j = 25\ ^\circ\text{C}$	Max.	10	μA
		$T_j = 150\ ^\circ\text{C}$		6	mA

Table 4. Thermal parameters

Symbol	Parameter		Value	Unit
$R_{th(j-c)}$	Junction to case (DC)	Max.	1.5	$^\circ\text{C}/\text{W}$
$R_{th(j-a)}$	Junction to ambient (DC)	Typ.	60	

1.1 Characteristics curves

Figure 1. Maximum average power dissipation versus average on-state current

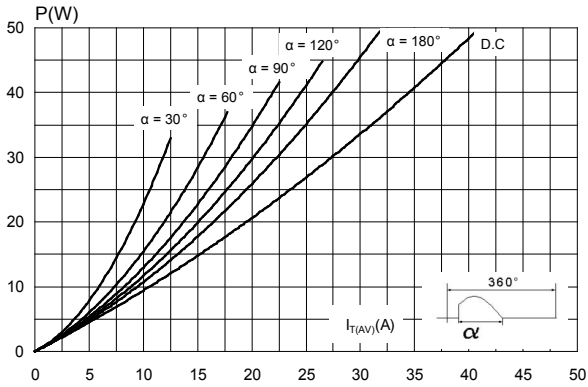

Figure 2. Average and DC on-state current versus case temperature

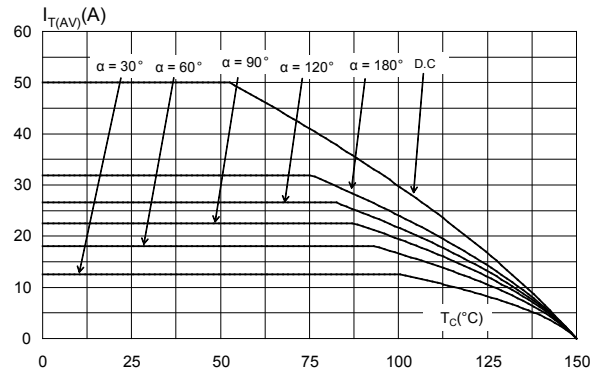

Figure 3. Average and D.C. on state current versus ambient temperature

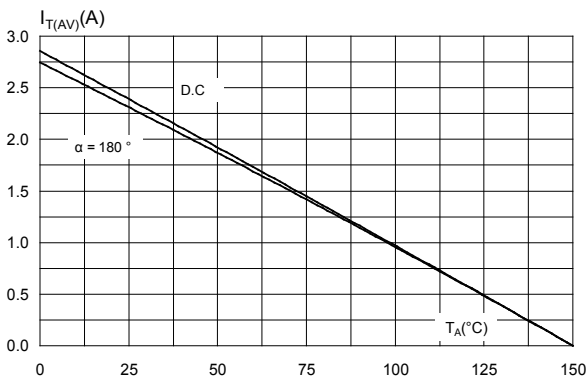

Figure 4. Relative variation of thermal impedance versus pulse duration

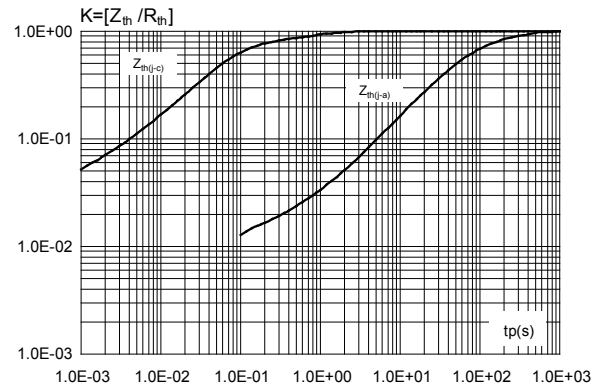

Figure 5. Relative variation of gate trigger current and gate voltage versus junction temperature (typical values)

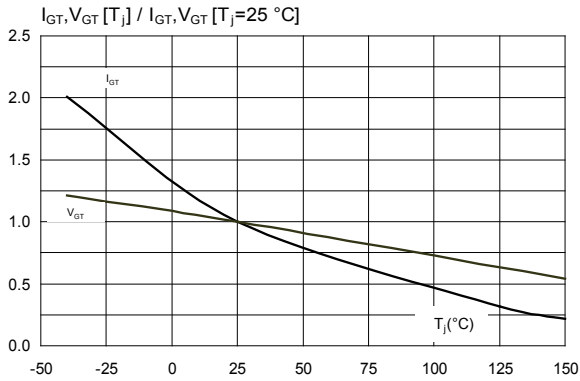

Figure 6. Relative variation of holding and latching current versus junction temperature (typical values)

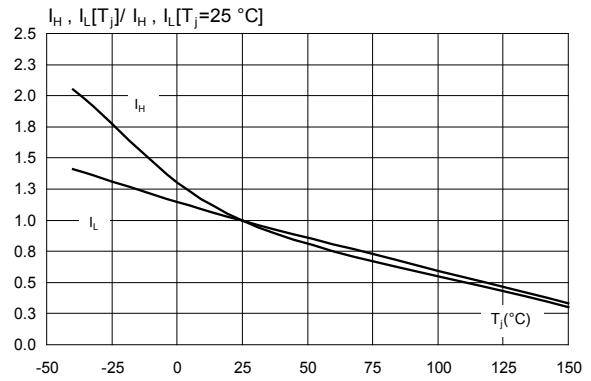

Figure 7. Relative variation of static dV/dt immunity versus junction temperature (typical values)

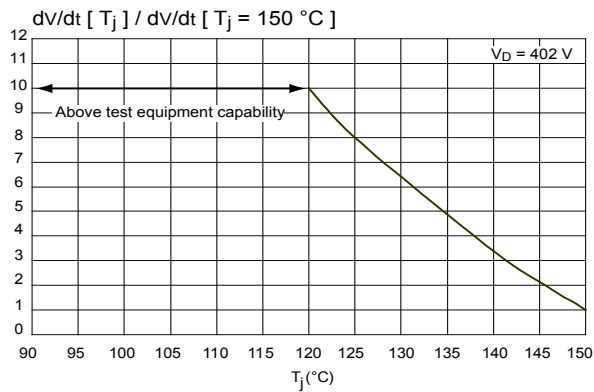

Figure 8. Surge peak on-state current versus number of cycles

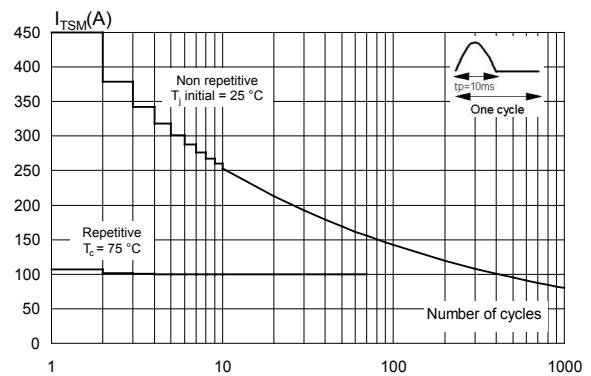

Figure 9. Non repetitive surge peak on-state current for a sinusoidal pulse with width $t_p < 10$ ms

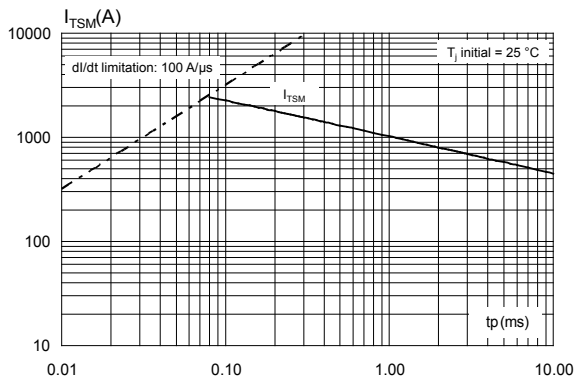

Figure 10. On-state characteristics (maximum values)

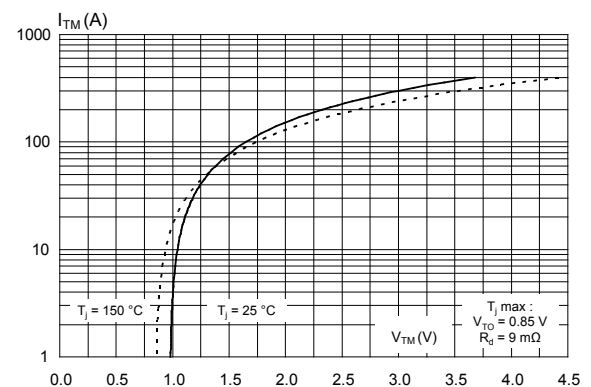
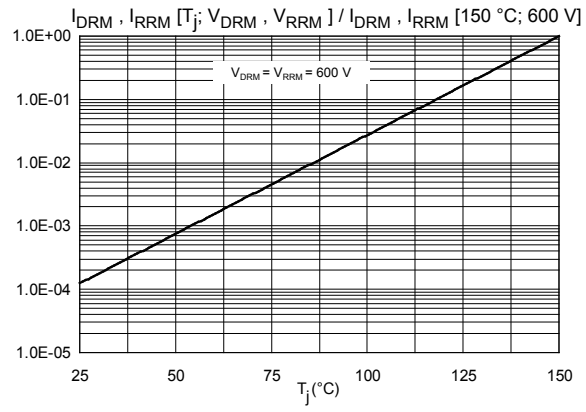

Figure 11. Relative variation of leakage current versus junction temperature



2 Application information

2.1 Overvoltage crowbar protection

An application featuring the strong current robustness of TN5015H-6I is the overvoltage crowbar protection, implemented in AC/DC switch mode power supply. An application global schematic is shown [Figure 12. Global schematic of a crowbar overvoltage protection application.](#)

Figure 12. Global schematic of a crowbar overvoltage protection application

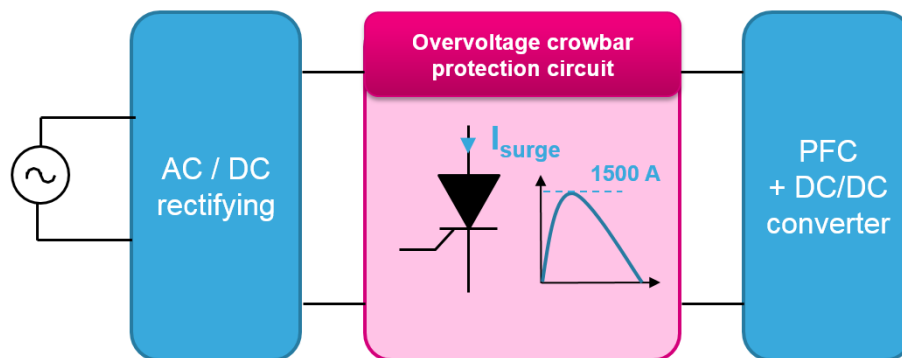

In case of overvoltage on line power terminals (example: lightning event), the voltage is rising quickly across the DC/DC module and can reach voltages limitations of devices, leading to possible application failure. The overvoltage crowbar protection answers to this issue by placing the SCR in parallel of the rectifier bridge output, and limiting the induced surge current during electrical over-stress.

The protection principle is to trig the TN5015H-6I when the overvoltage reaches the maximum authorized voltage. At TN5015H-6I turn-on, the electrical overvoltage stress becomes an overcurrent stress, flowing through the TN5015H-6I. No more voltage stress is applied across the down stream converter and the TN5015H-6I absorbs the overcurrent, making the application safe.

Additionally, the AC/DC SMPS efficiency and stand-by losses are not impacted by the protection thanks to the very low leakage current of the TN5015H-6I.

2.2 Peak pulse current robustness

The TN5015H-6I overcurrent capability is guaranteed through a specific parameter called peak pulse current: I_{PP} . This is the maximum current robustness of TN5015H-6I for an 8/20 μ s current waveform, as described in the IEC61000-4-5 standard.

The Figure 13. I_{PP} 8/20 μ s test circuit illustrates the test circuit for the I_{PP} parameter. The overstress is applied 10 times (according to the same standard) with a 1.2/50 μ s overvoltage and 8/20 μ s overcurrent stress generator.

Figure 13. I_{PP} 8/20 μ s test circuit

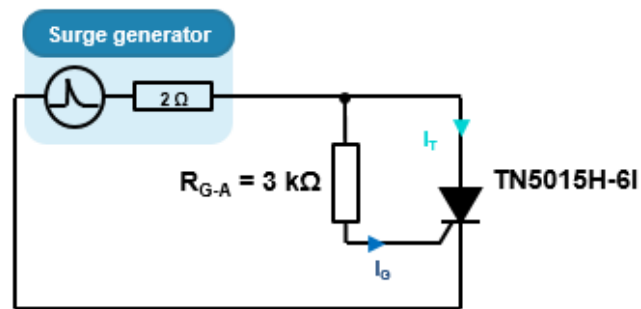

The Figure 14. I_{PP} 8/20 μ s test waveform (left part) is the 8/20 μ s waveform of current through the TN5015H-6I under test. The maximum gate current in this case is 350 mA (zoom at SCR triggering in the right part) and the maximum non-repetitive rate of current $(di/dt)_{OC}$ is 250 A/ μ s.

Figure 14. I_{PP} 8/20 μ s test waveform

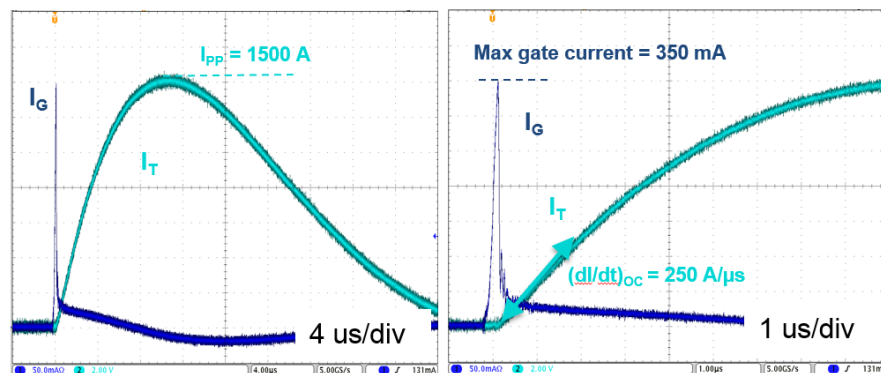

3 Package information

In order to meet environmental requirements, ST offers these devices in different grades of ECOPACK® packages, depending on their level of environmental compliance. ECOPACK® specifications, grade definitions and product status are available at: www.st.com. ECOPACK® is an ST trademark.

3.1 TO-220AB insulated package information

- Molding compound resin is halogen-free and meets UL standard level V0
- Lead-free package leads finishing
- ECOPACK®2 compliant

Figure 15. TO-220AB insulated package outline

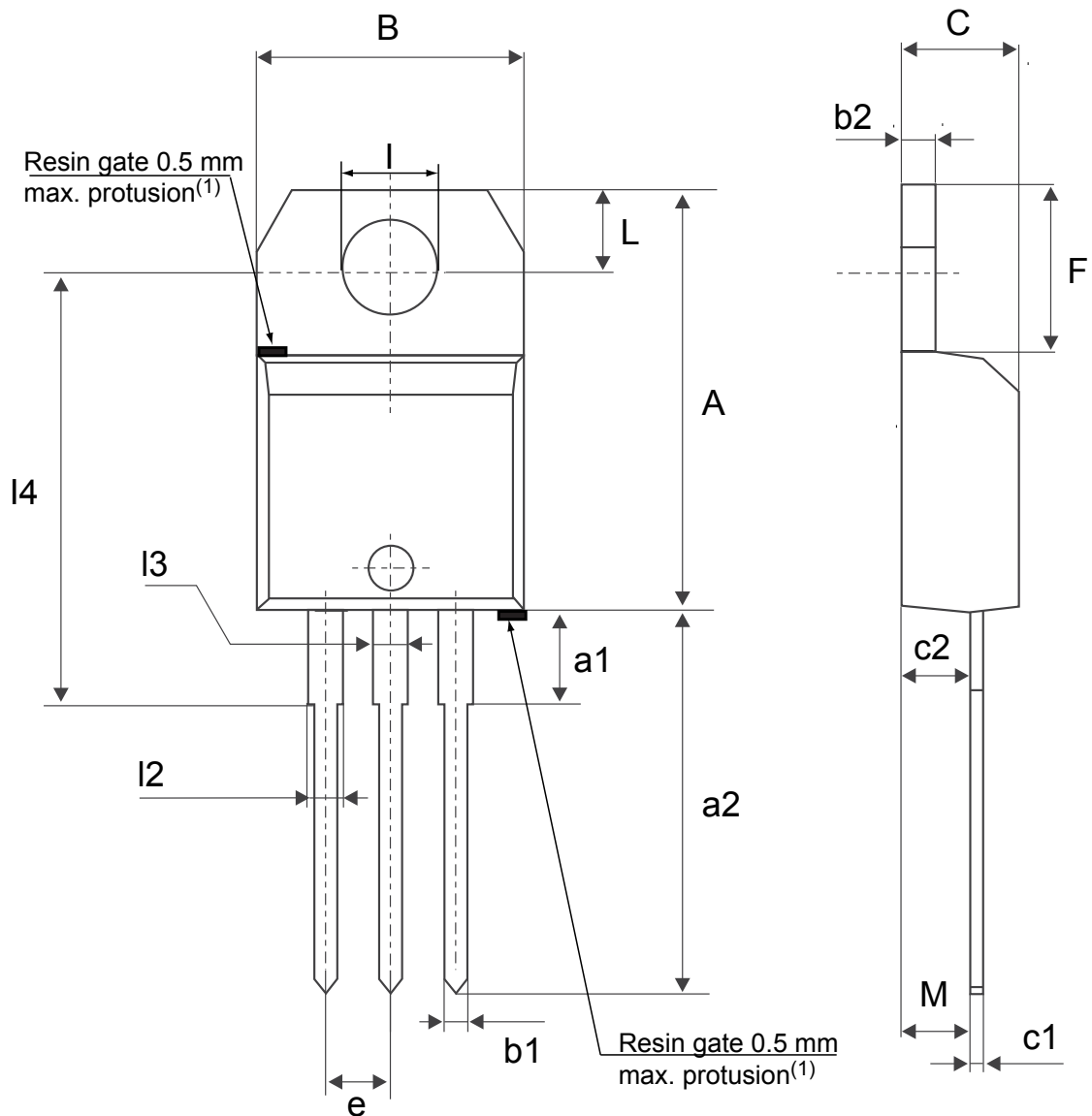

(1) Resin gate position accepted in one of the two positions or in the symmetrical opposites.

Table 5. TO-220AB insulated package mechanical data

Ref.	Dimensions					
	Millimeters			Inches ⁽¹⁾		
	Min.	Typ.	Max.	Min.	Typ.	Max.
A	15.20		15.90	0.5984		0.6260
a1		3.75			0.1476	
a2	13.00		14.00	0.5118		0.5512
B	10.00		10.40	0.3937		0.4094
b1	0.61		0.88	0.0240		0.0346
b2	1.23		1.32	0.0484		0.0520
C	4.40		4.60	0.1732		0.1811
c1	0.49		0.70	0.0193		0.0276
c2	2.40		2.72	0.0945		0.1071
e	2.40		2.70	0.0945		0.1063
F	6.20		6.60	0.2441		0.2598
I	3.73		3.88	0.1469		0.1528
L	2.65		2.95	0.1043		0.1161
I2	1.14		1.70	0.0449		0.0669
I3	1.14		1.70	0.0449		0.0669
I4	15.80	16.40	16.80	0.6220	0.6457	0.6614
M		2.6			0.1024	

1. Inch dimensions are for reference only.

4 Ordering information

Figure 16. Ordering information scheme

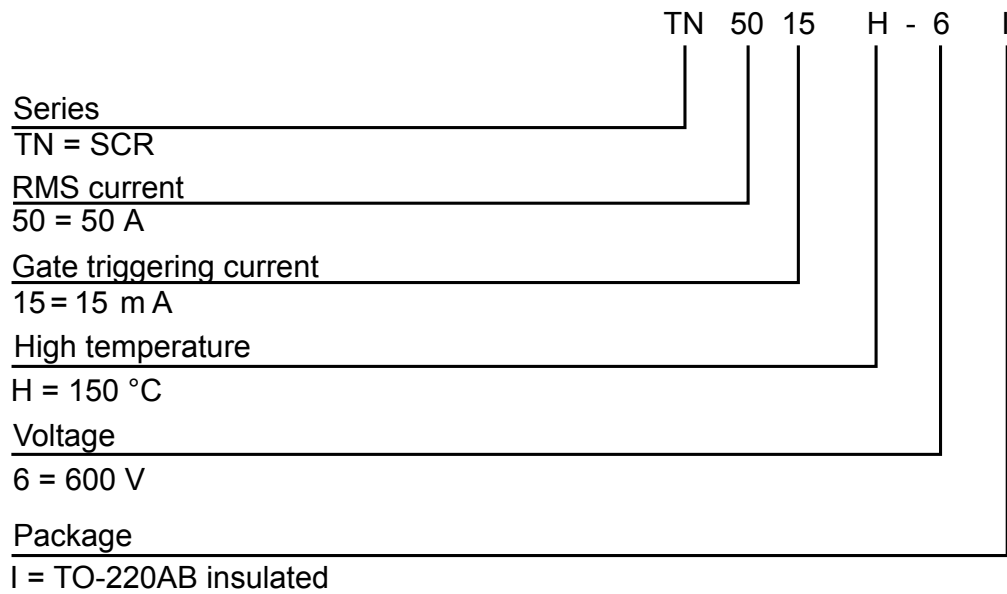

Table 6. Ordering information

Order code	Marking	Package	Weight	Base qty.	Delivery mode
TN5015H-6I	TN5015H6I	TO-220AB ins.	2.3 g	50	Tube

Revision history

Table 7. Document revision history

Date	Revision	Changes
02-Jun-2017	1	Initial release.
01-Dec-2017	2	Inserted Section 6: "Application information" and updated Table 2: "Absolute maximum ratings (limiting values), Tj = 25 °C unless otherwise specified"
08-Oct-2018	3	Updated Section Cover image .

IMPORTANT NOTICE – PLEASE READ CAREFULLY

STMicroelectronics NV and its subsidiaries (“ST”) reserve the right to make changes, corrections, enhancements, modifications, and improvements to ST products and/or to this document at any time without notice. Purchasers should obtain the latest relevant information on ST products before placing orders. ST products are sold pursuant to ST’s terms and conditions of sale in place at the time of order acknowledgement.

Purchasers are solely responsible for the choice, selection, and use of ST products and ST assumes no liability for application assistance or the design of Purchasers’ products.

No license, express or implied, to any intellectual property right is granted by ST herein.

Resale of ST products with provisions different from the information set forth herein shall void any warranty granted by ST for such product.

ST and the ST logo are trademarks of ST. All other product or service names are the property of their respective owners.

Information in this document supersedes and replaces information previously supplied in any prior versions of this document.

© 2018 STMicroelectronics – All rights reserved

Mouser Electronics

Authorized Distributor

Click to View Pricing, Inventory, Delivery & Lifecycle Information:

[STMicroelectronics:](#)

[TN5015H-6I](#)